

Experience in wide deployment of mixed Wired/Wireless/Fiber network in Kathmandu valley

Samit Jana

samit@wlink.com.np

WorldLink Communications Pvt.Ltd.



Outline

- Introduction
- Rationale for deploying Broadband over various medium
- Phases of Deployment and Problems
- Network topology diagrams and pics

Challenges

- Political instability, which makes difficult to make long term Investment and plans
- Connected to the Internet backbone via expensive but slow Satellite links.
- Majority of people still don't know what is internet and/or use of it, lack of quality education and awareness.
- GDP of the people is extremely low, therefore Lack of market.
- Stiff and Cut throat competition, and monopolistic nature of Telcos.
- Difficult Terrain for the rural and pops connectivity.

Our Vision

We are focused primarily on the Need of the people

Connect everyone in the Nepal to the Internet...!

Kathmandu Valley

- Capital of Nepal.
- It covers an area of 280sq miles at an elevation of 1,300m
- Population approx. 2.8 million
- Internet users probably around just 3 million in the whole country
- Total active accounts approx. 60,000 shared among all ISPs
- 33 operational ISP/NSP
- Till date all ISPs are dependent on VSAT to get connected with Internet backbone
- State owned Local telco has aquired fiber connectivity with BSNL,India , but local ISPs has not bought transit yet



Brief Introduction of WorldLink



- Established in 1995, with just a single PC and modem
- Currently have 102 servers, 49 routers, 47 managed switches, 18 NAS in core network
- Subscribes over 65mbps of IP bandwidth over Satellite
- Over 25,500 active accounts and 300 employees
- Internet market share of 41%
- Network coverage all over valley and at 13 major cities of the country
- Currently holds /18 Ipv4 address space , AS 17501
- Co-locate Akamai Servers
- Mostly use Unix and other Open Source System for its Network Operation

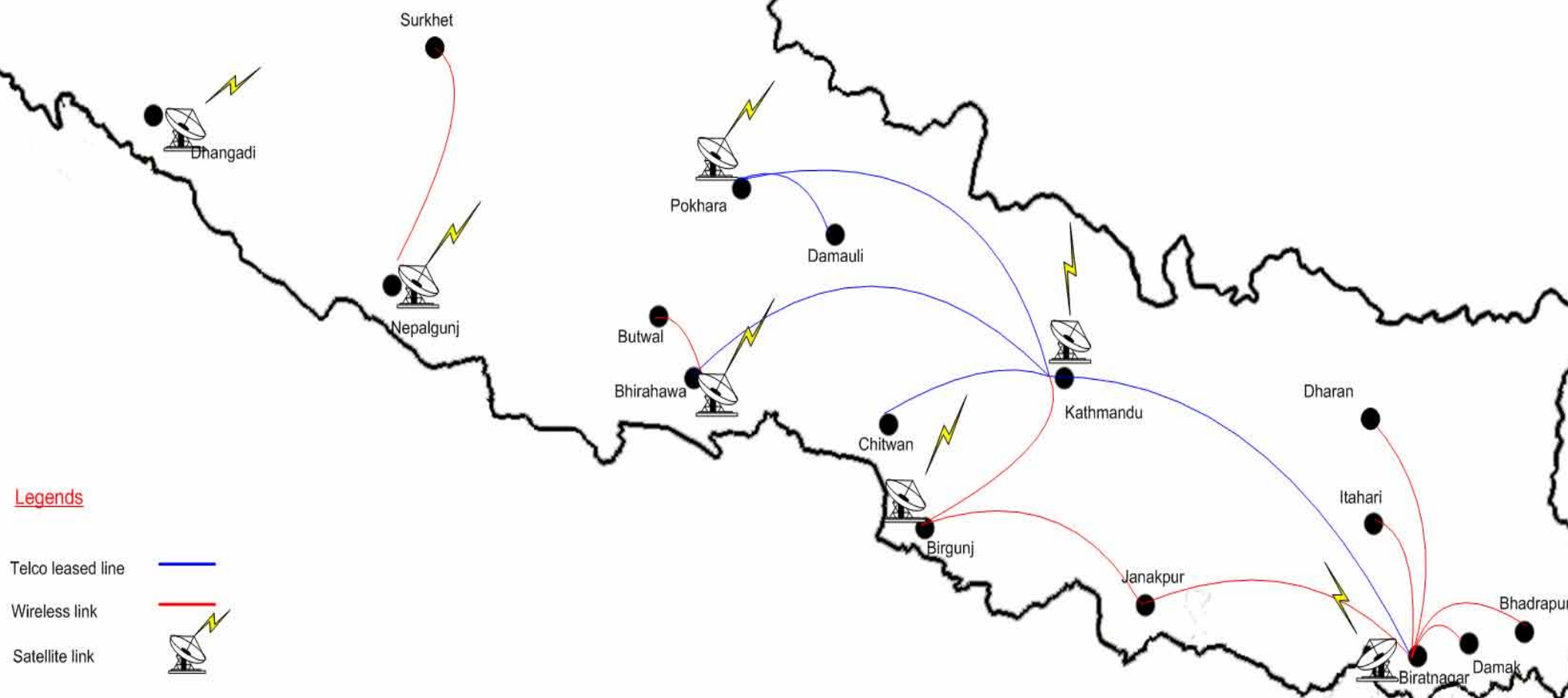

Physical Diagram of WorldLink's National Network



Legends

- Telco leased line 
- Wireless link 
- Satellite link 

Worldlink's Internal Network

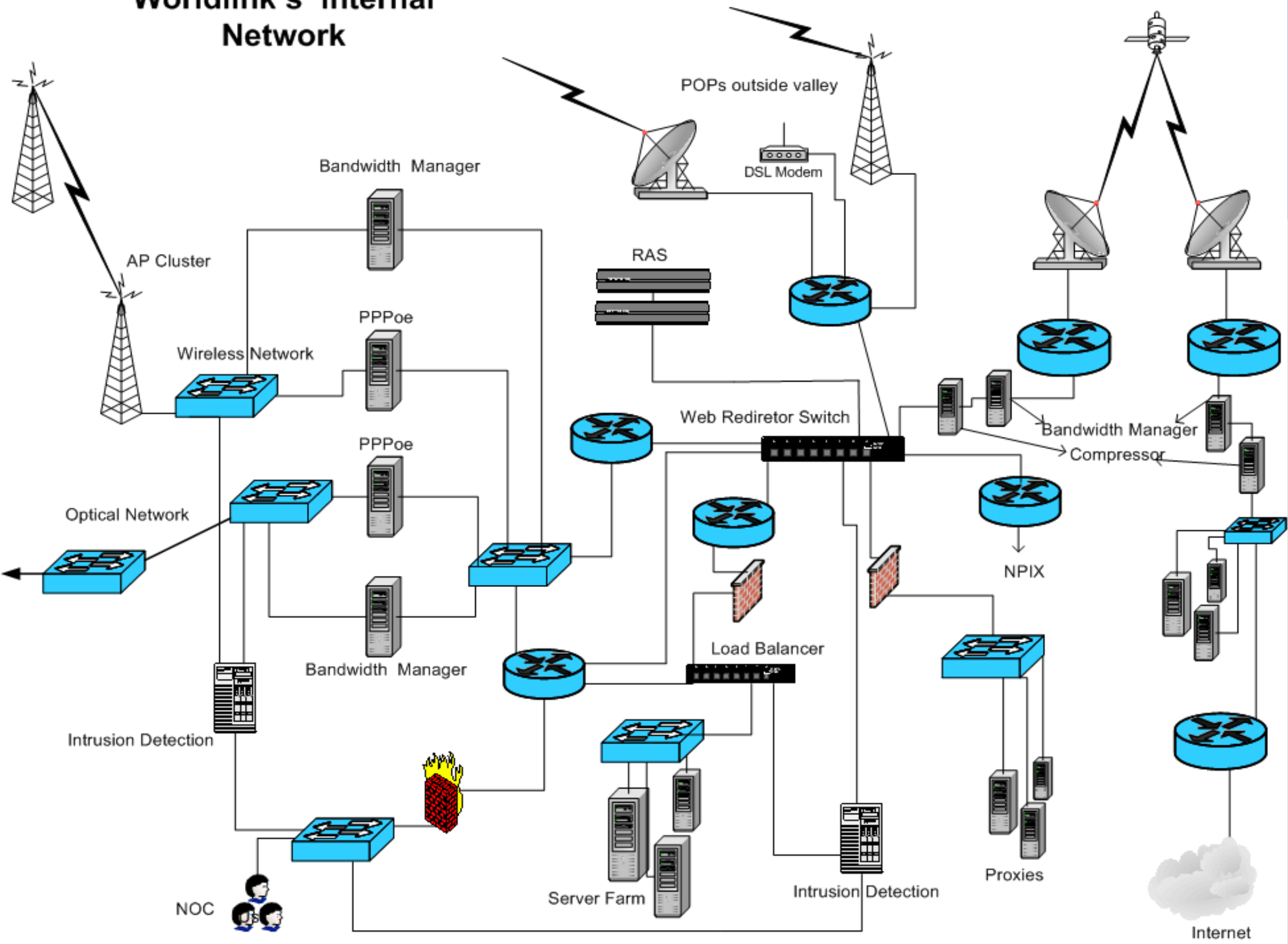

Rationale for wireless broadband

- Until 2002, dependant fully on telco leased-line and point-to-point wireless to provide few corporate connectivity
- Point-to-point wireless is expensive and not so scalable
- Telco leased-lines were unreliable and telco was reluctant to share its infrastructure with private ISPs
- Point-to-multipoint wireless would be reliable, quick to deploy and cost-effective compared to wireline solutions

Deployment of Wireless Phase 1

- Introduced 5.2Ghz Motorola Canopy Point to Multipoint Platform in December 2002
- Started with static IP allocation for the clients
- Wireless Broadband gained unexpected popularity
- By the end of 2003 over 400 new medium-sized corporate customers subscribed for both Internet and VPN data service
- Satellite IP bandwidth utilization increased from 8Mbps to 18Mbps within 1 yr.
- Price plummeted from \$500 to \$180 for 64kpbs/month

Major problems encountered Phase 1

- Unnecessary packets from protocols like netbios, bootp, igmp ms-ds(445) etc..
- Random arp spoofing and icmp attacks
- Occasional packet flooding due to faulty NIC,router's port and virus
- Misuse of IP addresses belonging to other customers and IP Conflicts
- Default Gateway IP abuse
- Exposure of PC's workgroup via Network Neighborhood of Netbios/NetBEUI protocol enable Windows PCs
- Few Wireless Firmware and GPS sync related.

Scaling L2 is tough...might be.. Impossible..?? :(

Countermeasures Phase 1

- Motorola new firmware release with packet filtering and NAT in subscriber equipment in late 2003 solved the majority of problems
- Created separate 24*7 proactive wireless monitoring and support team
- Installed packet sniffer and ran arpwatch scripts and enabled alerts and notifications. Enabled MAC+IP Filtering and packet rate limiting in the firewall of bandwidth manager
- Deployed broadband routers to avoid connecting the ethernet cable directly on the PC or enabled NAT in SM
- Ran scripts to automatically reset the AP based on the threshold of error counts of GPS status of AP
- Created monitoring and alerting scripts based upon SM, AP and switches MAC table and packet counts
- Educated customers and we still are ... :)

Encouragement..!

Deployment of Wireless cont... Phase 2

- Late 2003, introduced PPPoE-based broadband services on the wireless network to target small and medium businesses and SOHO and home users who could not afford corporate rates
- PPPoE gave us the same classic features of AAA as in traditional dialup
- Introduced hours and volume-based broadband connectivity in an effort to bring down the cost of ownership
- Service was very successful. Over 700 subscribers by the end of 2004
- Price went down to around \$90 for 64kpbs/month
- IP bandwidth utilization went up to over 27Mbps
- Currently we have 67 Motorola Canopy Access Points serving over 2000 Subscriber Modules.

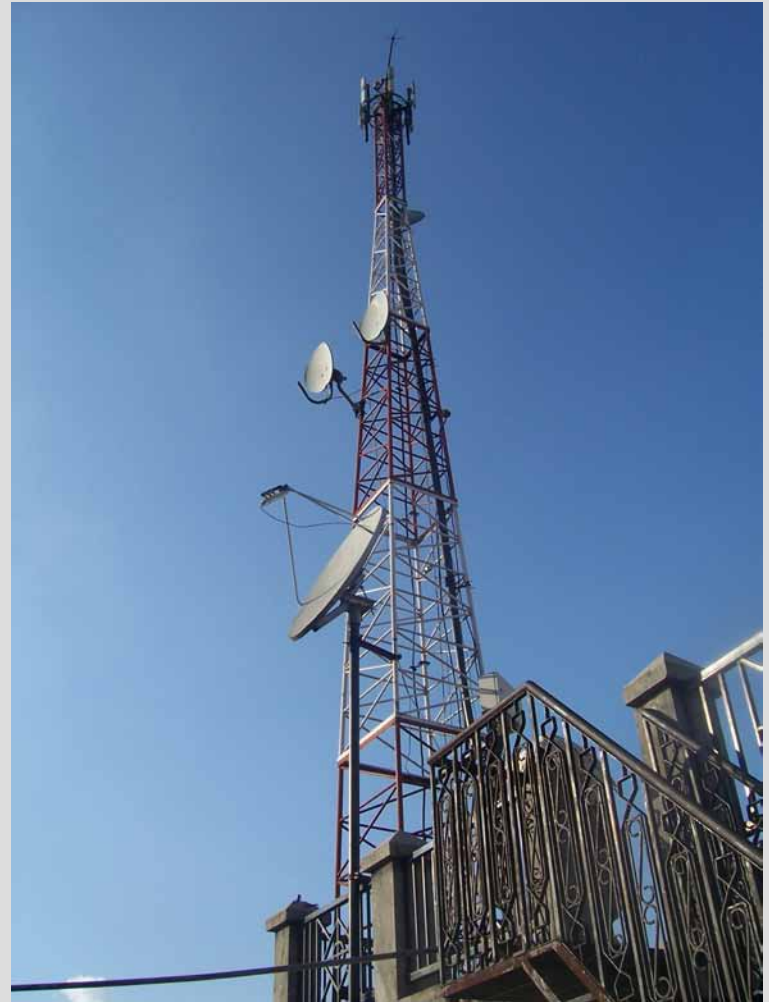



- Home
 - Configuration
 - Statistics
 - Tools
 - Logs
 - Account
 - PDA
 - Copyright
 - Logoff
- Account: root
Level: ADMINISTRATOR

Configuration => Protocol Filtering

Canopy Lite - 5.2GHz - Subscriber Module - 0a-00-3e-03-7f-b4

Packet Filter Configuration

Packet Filter Types :

- PPPoE
- All IPv4
 - SMB (Network Neighborhood)
 - SNMP
 - Bootp Client
 - Bootp Server
 - IPv4 Multicast
 - User Defined Port 1 (See Below)
 - User Defined Port 2 (See Below)
 - User Defined Port 3 (See Below)
 - All other IPv4
- ARP
- All others

User Defined Port Filtering Configuration

Port #1 :	<input type="text" value="135"/> (Decimal Value)
TCP :	<input checked="" type="radio"/> Enabled <input type="radio"/> Disabled
UDP :	<input checked="" type="radio"/> Enabled <input type="radio"/> Disabled
Port #2 :	<input type="text" value="1900"/> (Decimal Value)
TCP :	<input checked="" type="radio"/> Enabled <input type="radio"/> Disabled
UDP :	<input checked="" type="radio"/> Enabled <input type="radio"/> Disabled
Port #3 :	<input type="text" value="445"/> (Decimal Value)
TCP :	<input checked="" type="radio"/> Enabled <input type="radio"/> Disabled

Major Problems Phase 2

- Severe packet loss on AP having no. of higher no of associated SMs (over 40) and due to traffic bottleneck.
 - Added additional APs.
 - Upgraded the Classic APs to Advantage Platform
 - Added additional AP and segmented the AP clusters for PPPoE and Static IP customers.
 - Ran out of IP address space and we acquired additional /19 from APNIC

Confident...!...L2 can be scaled....! :)

Rationale for Last Mile Ethernet

- Most dial-up customers were paying more to the telco to connect to the ISP than the cost of Internet to the ISP.
- Most of these customers pay from \$10 to \$20 per month for Internet and an additional \$12 to \$25 per month to the Telco.
- These customers would not be able to afford wireless Internet due to the high cost of subscriber-end equipment.
- We needed our own last mile solution that was low-cost, moderate scalable and could be rolled out in phases.

Solution.. Ethernet...! Simple and Stupid...! ;)

Deployment of Last Mile Ethernet with Wireless backhaul Phase 3

- On electricity poles, installed waterproof metal boxes with a low-cost (less than \$20), VLAN-aware switch inside
- The poles are roughly 80-150m apart. Cascaded the switches linearly using custom Shielded Twisted Pair (STP) CAT5e cable
- In a neighbourhood, all Ethernet segments connect at one point to one switch. This switch is connected to our network using wireless SM. This way we have small ethernet networks wherever we had our wireless coverage

Last Mile Connectivity Layout by Electrical Poles

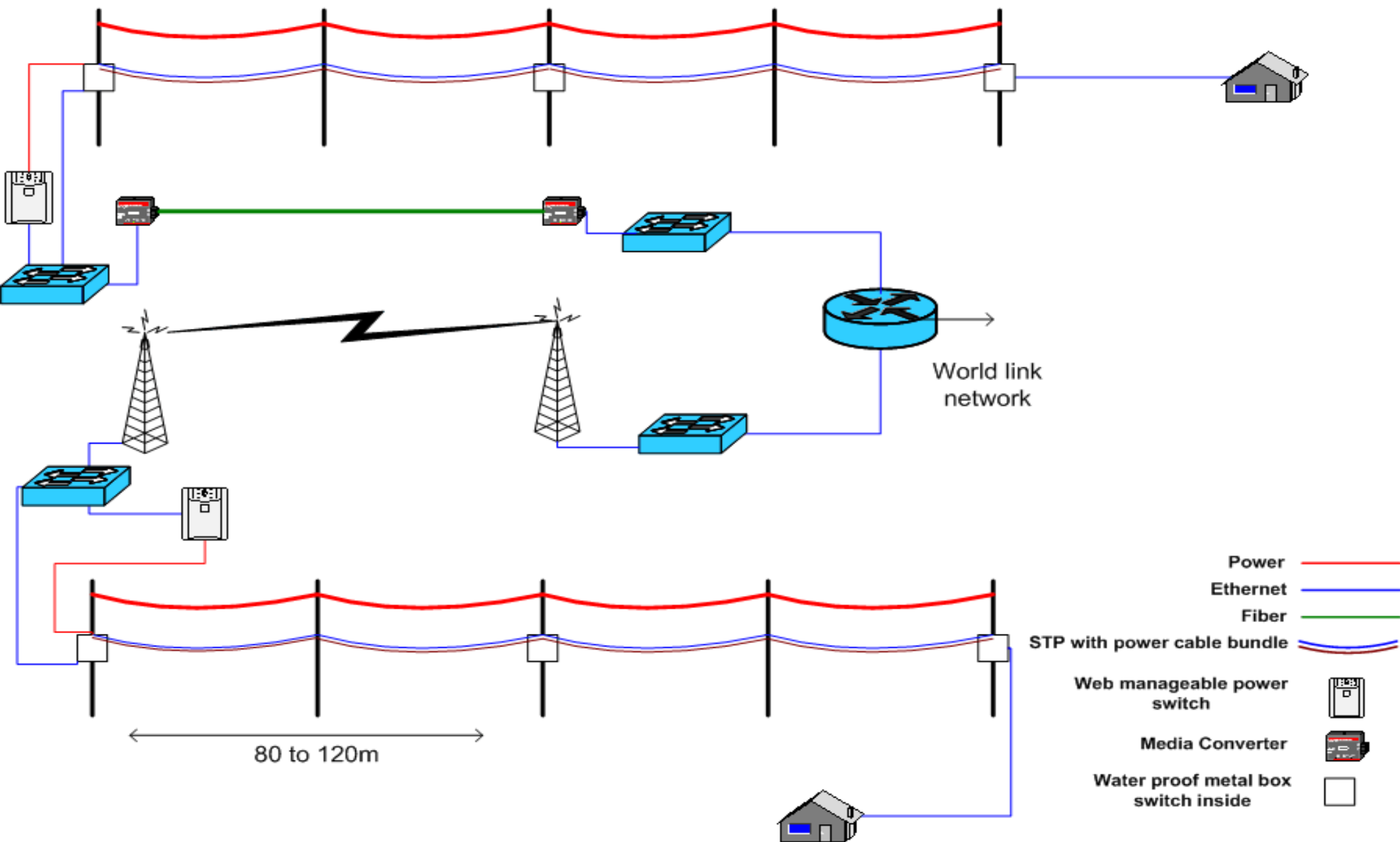

Deployment of Last Mile Ethernet with Wireless backhaul cont.... Phase 3

- We have Ethernet segments with up to 20 cascaded switches covering around 2km operating at 10Mb/HD mode.
- Every customers were kept in separate VLAN
- Only PPPoE connection is being allowed
- By end of 2006, over 4200 customers served by Ethernet. Over 2000 dialup customers migrated.
- Price brought down to \$15 (depending on service plan)
- IP Bandwidth utilization went up to 40Mbps
- Approx. 600km of Ethernet cable and 6500, 8port switches deployed

To Wireless Subscriber Module
or
Catalyst Switch Port

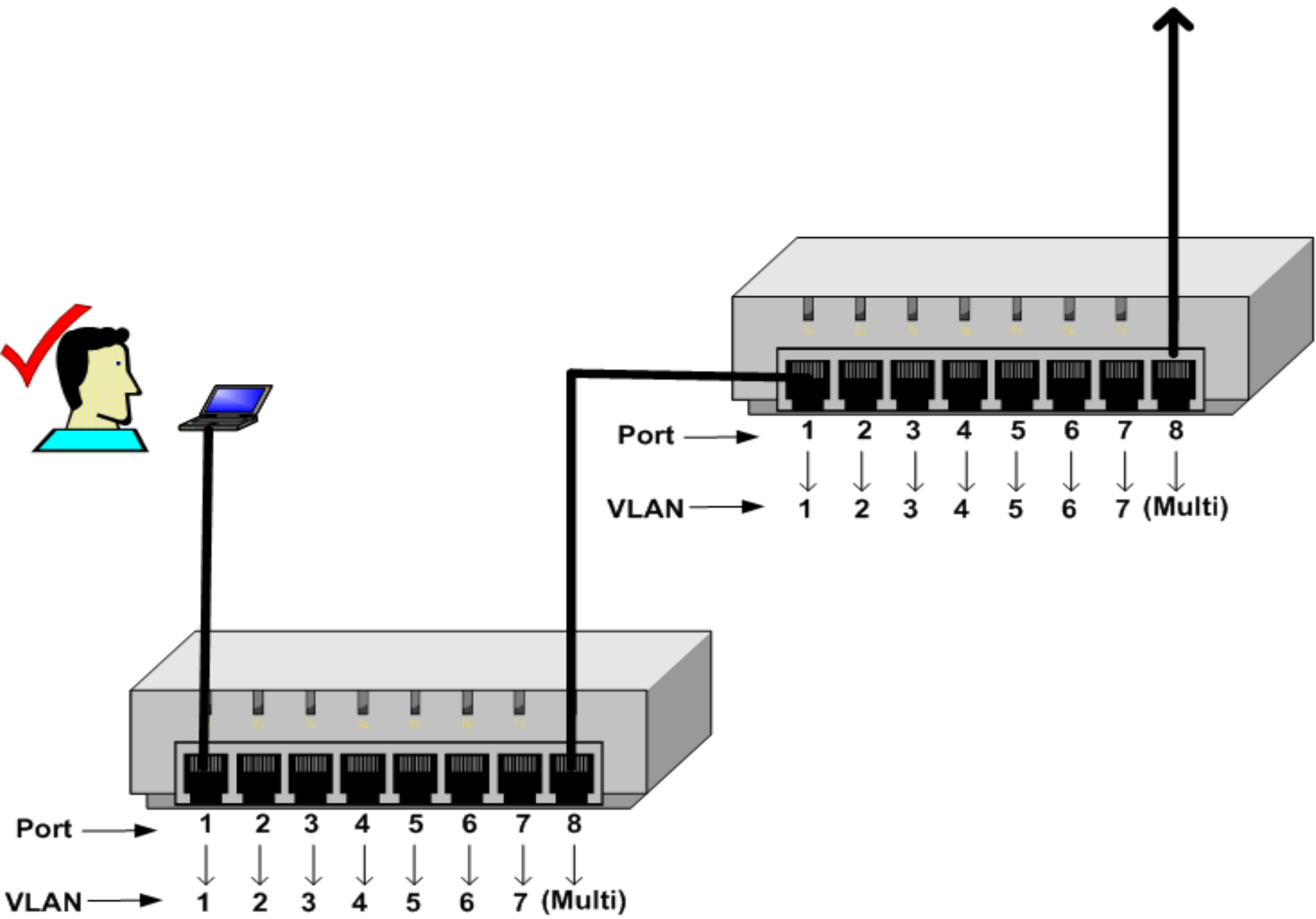

Major Problems and Counter measures Phase 3

- Distribution switch related. Cannot migrate to more reliable switches due to higher cost
- Occasional electrical surges damaging customer's PC and switches
 - Started using Ethernet Surge Protectors
- Switch hangs
 - Installed remote-accessible power controllers to power cycle switches remotely using scripts
 - Replaced the power module with rating 80~130 VAC.
 - Increased the gauge of copper wire carrying A/C current.
- Occasional ethernet cable and switch breaks/cuts and theft
- Faulty ethernet cables and broadband routers of customer creating a Loop subsequently broadcast storm, therefore created difficulties for other customers establishing pppoe connections

Deployment of Last Mile Ethernet Fiber for Backhaul Phase 4

- As the number of clients increased, the wireless backhauls were incapable of handling the higher throughput
- Early 2006, we rolled-out an optical fibre network
- Created a different optical fiber Ethernet network ring and gradually migrated the wireless links
- Over 450km of optical fibre cable deployed so far.
- 15 major network points of presence (POPs) and 75 smaller PoPs for Wireless and Ethernet distribution inside Kathmandu Valley
- No major issues till date...we are just running out of available Ips ...:)



SMT 8005 A03

Jw-Shtk-1303

WORLD LINK

•	•	•	•	•	•	•	•	•	•	DUP
•	•	•	•	•	•	•	•	•	•	SPD
•	•	•	•	•	•	•	•	•	•	LNK
1	2	3	4	5	6	7	8			

10/100M 8 Ports
Fast Ethernet Switch

10/100M 8 Ports
Fast Ethernet Switch

534

L2 Feature we use

Catalyst 2950G on Backbone Ring:

- Rapid Spanning Tree (RSTP) with Per Vlan Spanning Tree (PVST)
- Per port VLAN and VTP
- Storm Control
- MAC security
- Protected Ports
- Port based MAC and IP ACL

<http://www.cymru.com/gillsr/documents/catalyst-secure>

Worldlink's Metro Network

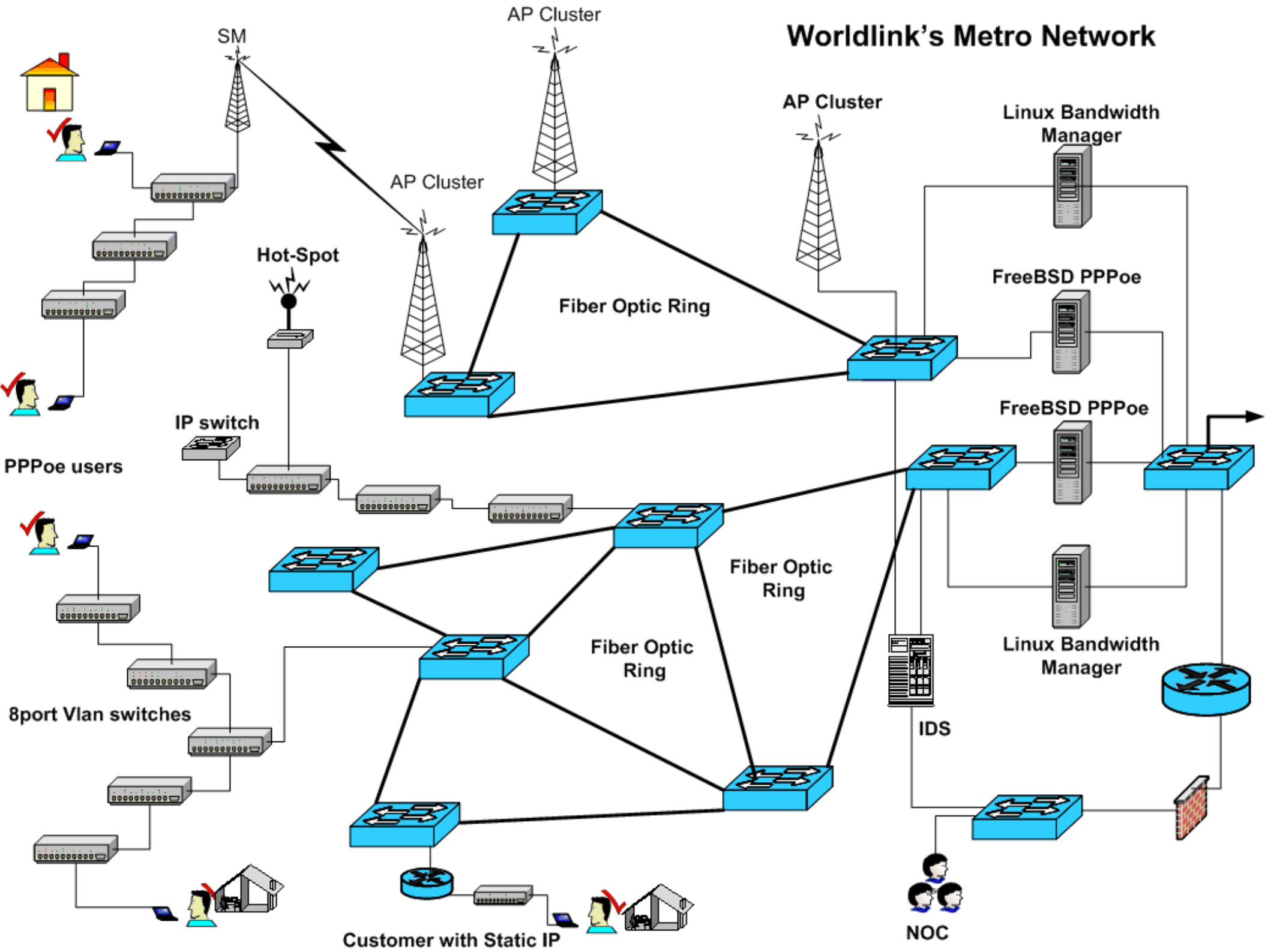

Monitoring Ethernet Network

- In addition with Nagios/OpenNMS, RRD/Mrtg/Cacti we developed our own application to trap the active mac-address and analyze the packets in the network.
- Based upon the user's pc's mac-address, packets and other user information database. Developed own Java based online monitoring system

Monitoring Unmanaged Switched Network

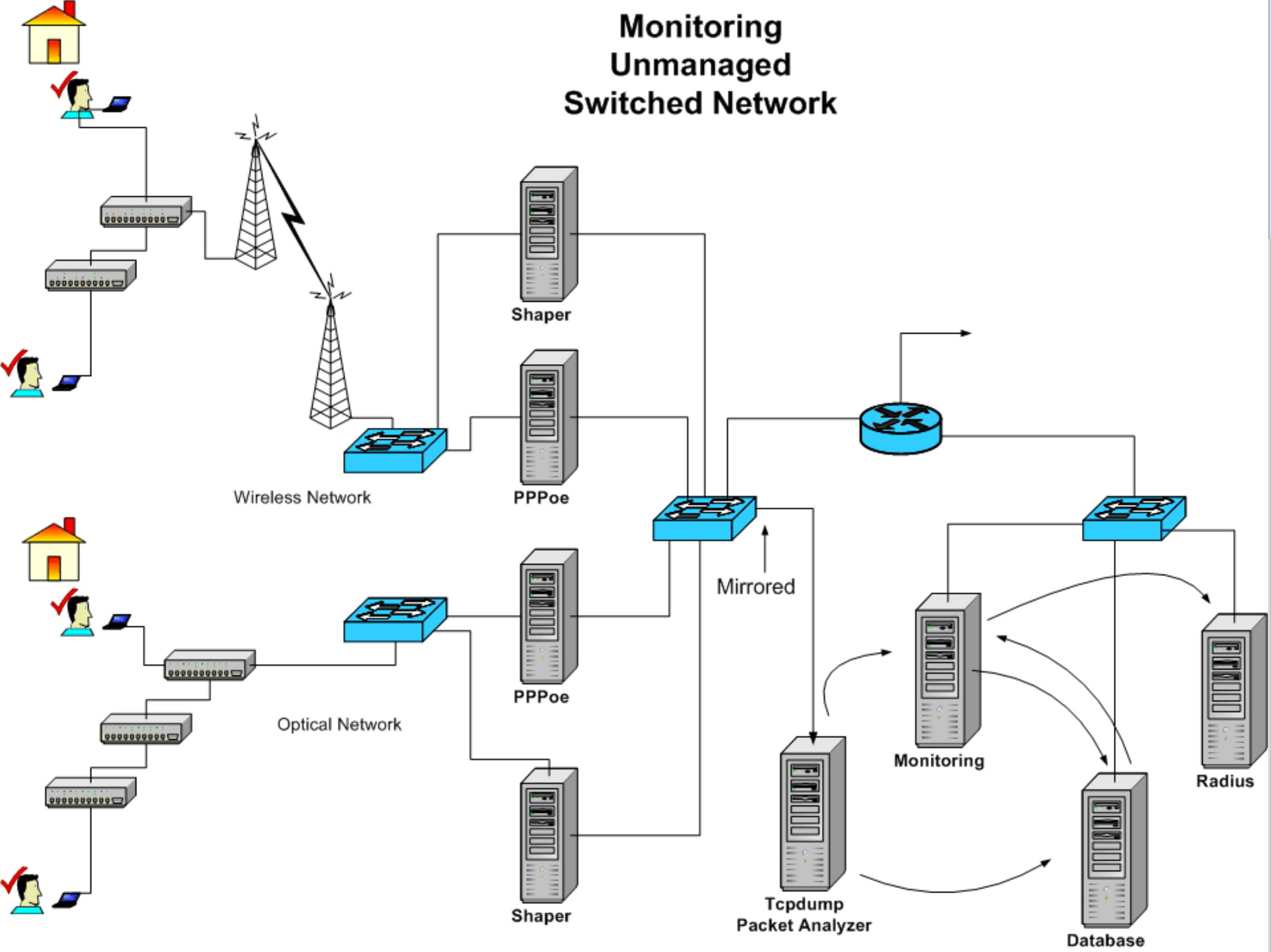

WORLDLINK Cable Cabs (Total Clients = 4125)

anamnagar cab(35) Active Switches: 26 Inactive Switches: 9 Total Clients : 115 Online Clients : 21	bagdole cab(15) Active Switches: 5 Inactive Switches: 10 Total Clients : 17 Online Clients : 2	balaju cab(66) Active Switches: 11 Inactive Switches: 55 Total Clients : 33 Online Clients : 5	balwatar cab(64) Active Switches: 28 Inactive Switches: 36 Total Clients : 61 Online Clients : 4	bhaisipati cab(39) Active Switches: 6 Inactive Switches: 33 Total Clients : 37 Online Clients : 1	bhatbhateni cab(38) Active Switches: 0 Inactive Switches: 38 Total Clients : 0 Online Clients : 0	bhimsengola cab(29) Active Switches: 17 Inactive Switches: 12 Total Clients : 50 Online Clients : 4	bhotebahal cab(1) Active Switches: 0 Inactive Switches: 1 Total Clients : 0 Online Clients : 0
bnagar cab(59) Active Switches: 34 Inactive Switches: 25 Total Clients : 104 Online Clients : 13	bns cab(37) Active Switches: 10 Inactive Switches: 27 Total Clients : 74 Online Clients : 5	boudha cab(53) Active Switches: 29 Inactive Switches: 24 Total Clients : 93 Online Clients : 11	chabahil cab(70) Active Switches: 43 Inactive Switches: 27 Total Clients : 166 Online Clients : 20	chakupat cab(29) Active Switches: 22 Inactive Switches: 7 Total Clients : 64 Online Clients : 7	chhetra cab(105) Active Switches: 58 Inactive Switches: 47 Total Clients : 214 Online Clients : 46	chundevi cab(26) Active Switches: 8 Inactive Switches: 18 Total Clients : 12 Online Clients : 2	csn test(1) Active Switches: 0 Inactive Switches: 1 Total Clients : 0 Online Clients : 0
dgt cab(61) Active Switches: 44 Inactive Switches: 17 Total Clients : 184 Online Clients : 17	gyn cab(36) Active Switches: 26 Inactive Switches: 10 Total Clients : 93 Online Clients : 12	kamaladi2 cab(3) Active Switches: 0 Inactive Switches: 3 Total Clients : 1 Online Clients : 0	kamaladi cab(8) Active Switches: 6 Inactive Switches: 2 Total Clients : 24 Online Clients : 8	khusibhu cab(52) Active Switches: 28 Inactive Switches: 24 Total Clients : 41 Online Clients : 5	koteswor cab(20) Active Switches: 16 Inactive Switches: 4 Total Clients : 21 Online Clients : 3	kulesh cab(32) Active Switches: 8 Inactive Switches: 24 Total Clients : 20 Online Clients : 1	kumari cab(30) Active Switches: 16 Inactive Switches: 14 Total Clients : 79 Online Clients : 7
lazimpat cab(71) Active Switches: 0 Inactive Switches: 71 Total Clients : 0 Online Clients : 0	maharajung cab(70) Active Switches: 16 Inactive Switches: 54 Total Clients : 68 Online Clients : 8	newbns cab(63) Active Switches: 41 Inactive Switches: 22 Total Clients : 150 Online Clients : 36	newroad cab(33) Active Switches: 21 Inactive Switches: 12 Total Clients : 83 Online Clients : 20	oldbns cab(73) Active Switches: 50 Inactive Switches: 23 Total Clients : 178 Online Clients : 29	pck cab(55) Active Switches: 47 Inactive Switches: 8 Total Clients : 156 Online Clients : 26	phulbari cab(56) Active Switches: 27 Inactive Switches: 29 Total Clients : 125 Online Clients : 9	psadak cab(92) Active Switches: 63 Inactive Switches: 29 Total Clients : 269 Online Clients : 50
ranjana cab(60) Active Switches: 49 Inactive Switches: 11 Total Clients : 192 Online Clients : 44	samatown cab(47) Active Switches: 18 Inactive Switches: 29 Total Clients : 24 Online Clients : 4	sama cab(63) Active Switches: 40 Inactive Switches: 23 Total Clients : 61 Online Clients : 9	saraswatinagar cab(50) Active Switches: 20 Inactive Switches: 12 Total Clients : 52 Online Clients : 7	shantikuna cab(56) Active Switches: 44 Inactive Switches: 12 Total Clients : 153 Online Clients : 14	shantinagar cab(37) Active Switches: 20 Inactive Switches: 17 Total Clients : 71 Online Clients : 9	sifal cab(47) Active Switches: 27 Inactive Switches: 20 Total Clients : 118 Online Clients : 11	sinamangal cab(33) Active Switches: 23 Inactive Switches: 10 Total Clients : 53 Online Clients : 10
smt cab(57) Active Switches: 38 Inactive Switches: 19 Total Clients : 147 Online Clients : 14	snp cab(57) Active Switches: 35 Inactive Switches: 22 Total Clients : 151 Online Clients : 11	soaltee cab(45) Active Switches: 24 Inactive Switches: 21 Total Clients : 31 Online Clients : 4	subidhanagar cab(20) Active Switches: 12 Inactive Switches: 8 Total Clients : 44 Online Clients : 6	sukhedhara cab(29) Active Switches: 15 Inactive Switches: 14 Total Clients : 45 Online Clients : 6	swayambhu cab(40) Active Switches: 0 Inactive Switches: 40 Total Clients : 1 Online Clients : 0	tahachal cab(31) Active Switches: 0 Inactive Switches: 31 Total Clients : 13 Online Clients : 0	teku cab(71) Active Switches: 39 Inactive Switches: 32 Total Clients : 115 Online Clients : 29
test cab(5) Active Switches: 0 Inactive Switches: 5 Total Clients : 7 Online Clients : 0	thamel cab(57) Active Switches: 40 Inactive Switches: 17 Total Clients : 128 Online Clients : 40	thapathali cab(26) Active Switches: 15 Inactive Switches: 11 Total Clients : 59 Online Clients : 7	tripu cab(18) Active Switches: 17 Inactive Switches: 1 Total Clients : 44 Online Clients : 14	usc cab(47) Active Switches: 13 Inactive Switches: 34 Total Clients : 84 Online Clients : 2			



■ Totally Active Active : 47
■ Inactive Inactive : 8
■ Intermediate

Name : jwl-plck-D05
 ParentName : jwl-plck-D04
 Status : Active-100
 Location : In front of Bakery
 Date : null
 Load : 13

Hide

jwl-plck-D06 <= P1	P5 => jjenish
cath joriot <= P2	P6 => chandrodaya
delegate <= P3	P7 =>
powerbizz <= P4	P8 => Uplink

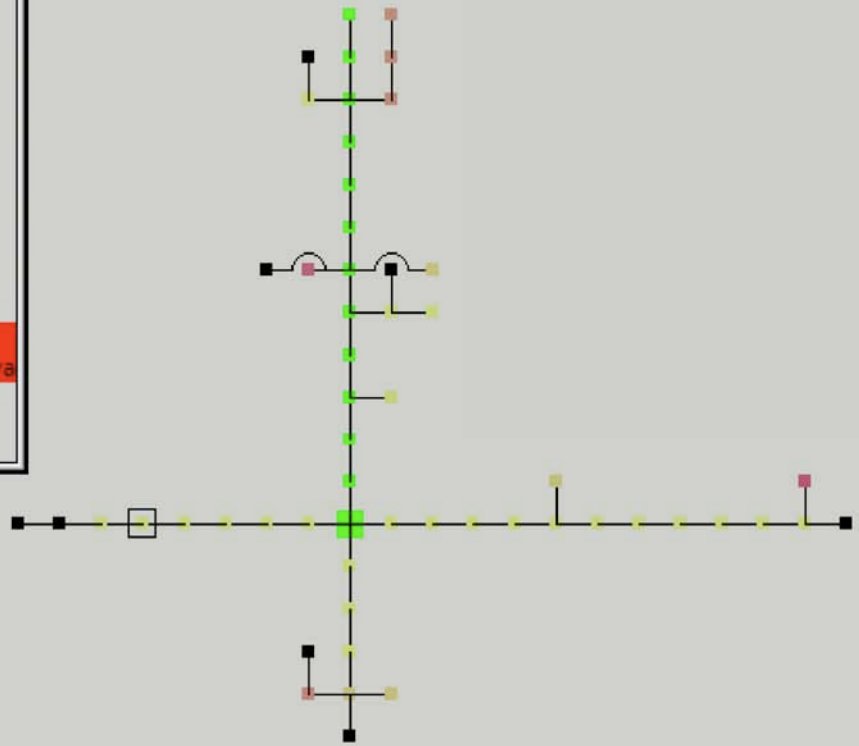



■ Totally Active Active : 22
■ Inactive Inactive : 11
■ Intermediate

Realtime Chart :: 202.166.217.214

Bandwidth (202.166.217.214)

■ Download (kbps): **87.88** ■ Upload (kbps): **0.00**



Name : nrd-nwr-d-B03.BR1
 ParentName : nrd-nwr-d-B03
 Status : Totally Active
 Location :
 Date : null
 Load : 4

flash <= P1	P5 => smarttech
<= P2	P6 =>
<= P3	P7 => dalmia
pdahal <= P4	P8 => Uplink

User Name : dalmia
 Pay Plan : 5330
 Mac : 00:16:76:8A:65:B0
 IP : 202.166.217.214
 Download : 58.59
 Upload : 4.87

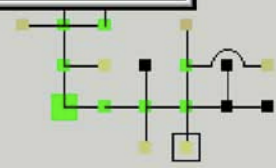

Currently Googling for..

In Wireless SM some additional firmware features :

- MAC + IP Filtering
- Packet Rate Limiting
- Possibilities of Inbound packet filtering
- SM to SM Isolation and VLAN.

In metro ethernet:

- Replace all unmanaged switches with affordable managed and feature rich industrial grade switches

Future Plans

- Get connected to Internet backbone via own Fibre ASAP..!
- Nationwide own Terrestrial Wireless Connectivity
- Broadband over Powerline

**Experience in wide deployment of
mixed Wired/Wireless/Fiber network
in Kathmandu valley**

Thank You...!

Questions, Comments, Suggestion??