

IPv6 Application Trial Services

2003/08/07

Tomohide Nagashima

Japan Telecom Co., Ltd.

Exceeds Your Needs

- ❑ Our Trial
- ❑ Service & Technology Details
- ❑ Activity & Future Plan

- Our Trial
- Service & Technology Details
- Activity & Future Plan

Activities for IPv6

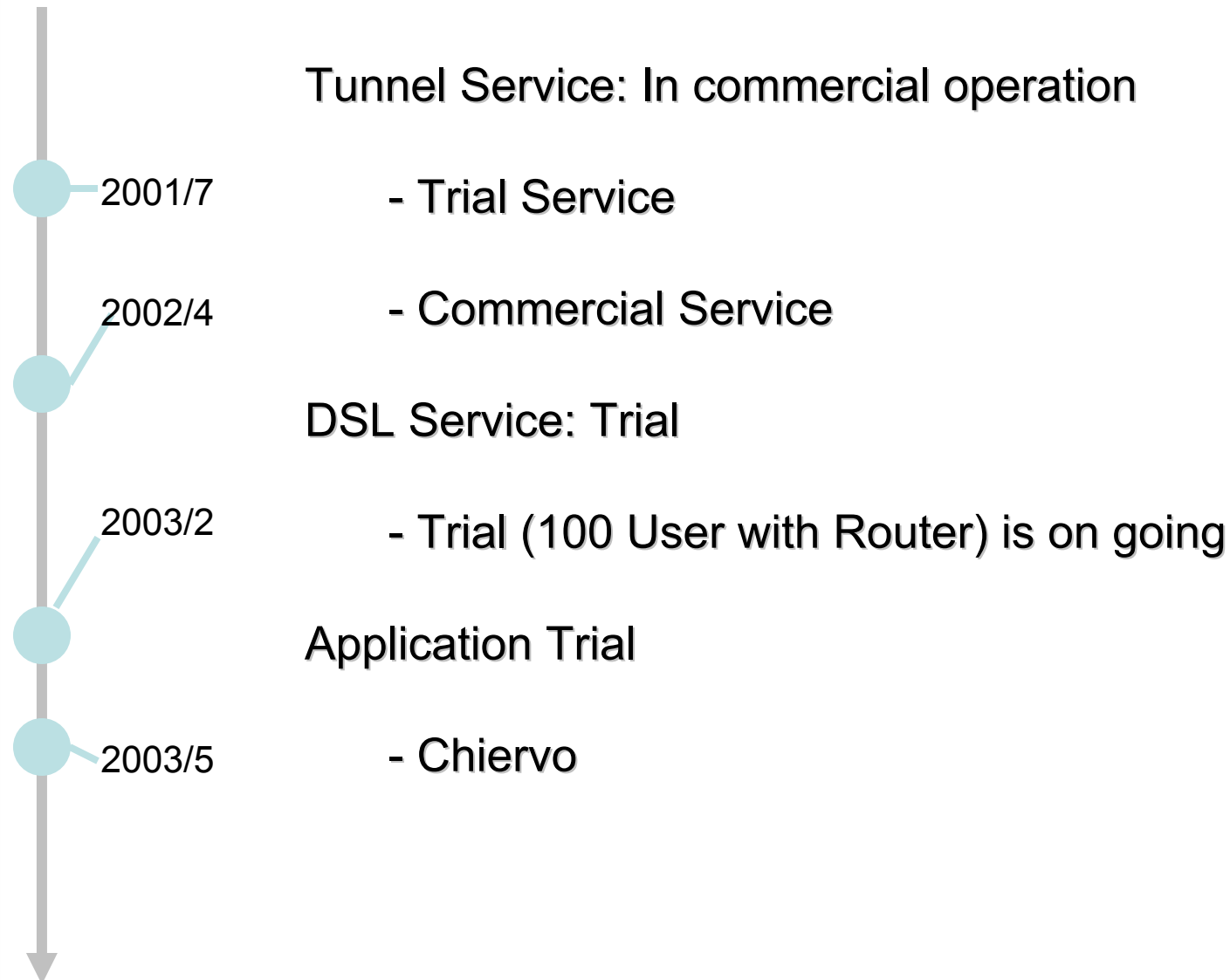

Overview of Application Trial

IPv6 Application Trial Service (Nickname: Chiervo)

“Integrated Service of Fileshare / Realtime communication via IPv6”

IM (Text, Voice Chat, File Transfer, Meeting)

P2P File Share Function, Streaming

- a. Purpose: Contribution to IPv6 promotion
- b. Feature: P2P Service (Available via IPv6) , IM -> SIP / SIMPLE
- c. Trial Period 2003/5/12 – 10/31
- d. Target: 1000 user (for our ISP or Feel6Farm)
- e. Fee: No Charge

Target Users

a. Target Users

Chiervo is designed for the Internet users who....

- Have relatively deeper knowledge about the Internet, and their family.
- Have interests in IPv6 trial and want to try new applications
- Get used to accessing the Internet from anywhere on-line PC is available

b. Requirement for Trial Users

- Windows XP+SP1
- IPv6 connectivity (provided by another trial service or by feel6)
- Compliance with specific rules (see <http://www.chiervo.net/> for details)

- ❑ Our Trial
- ❑ Service & Technology Details
- ❑ Activity & Future Plan

Network System Structure

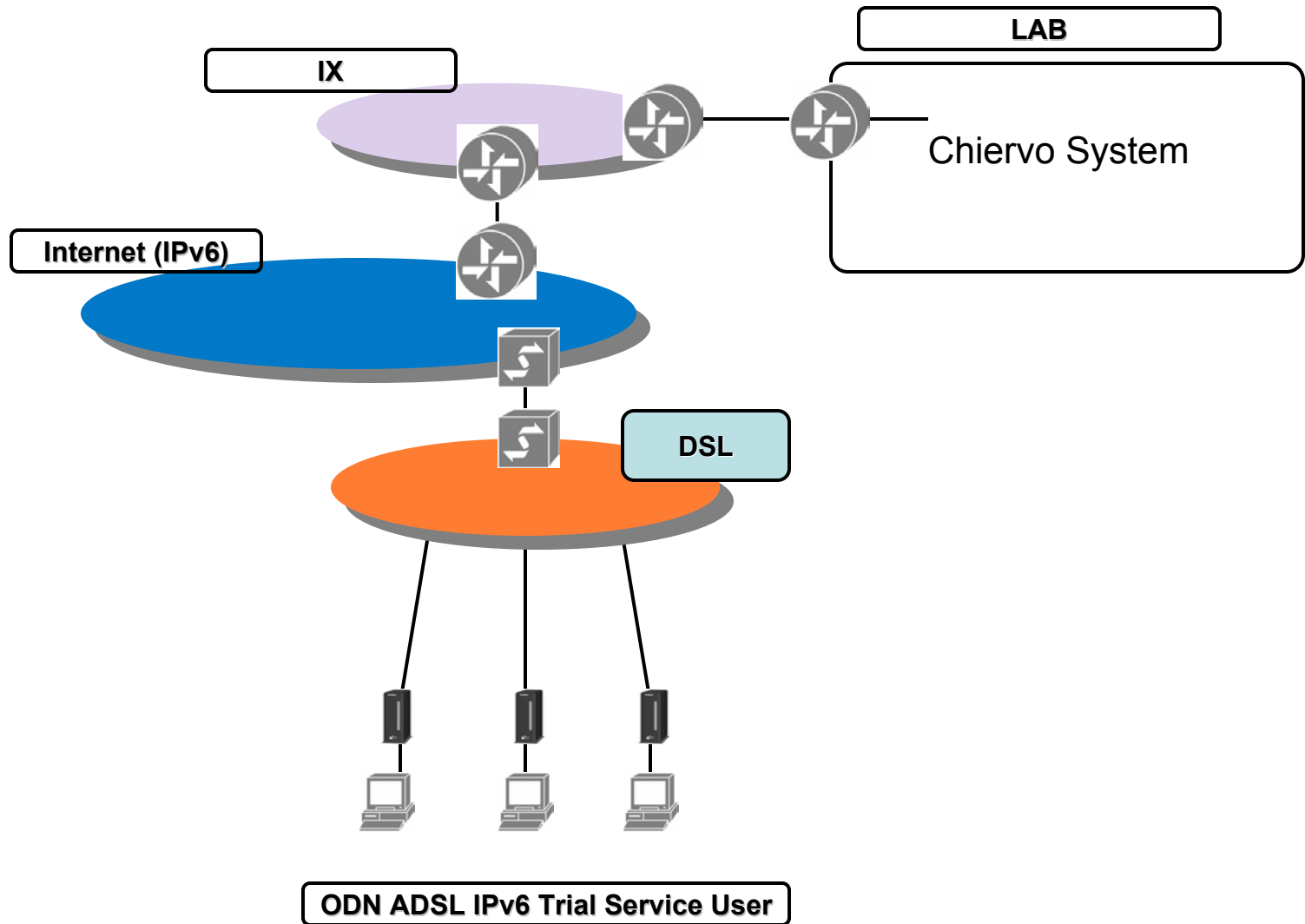

Technology Trends

Japan Telecom regards characteristic of IPv6 as End-End

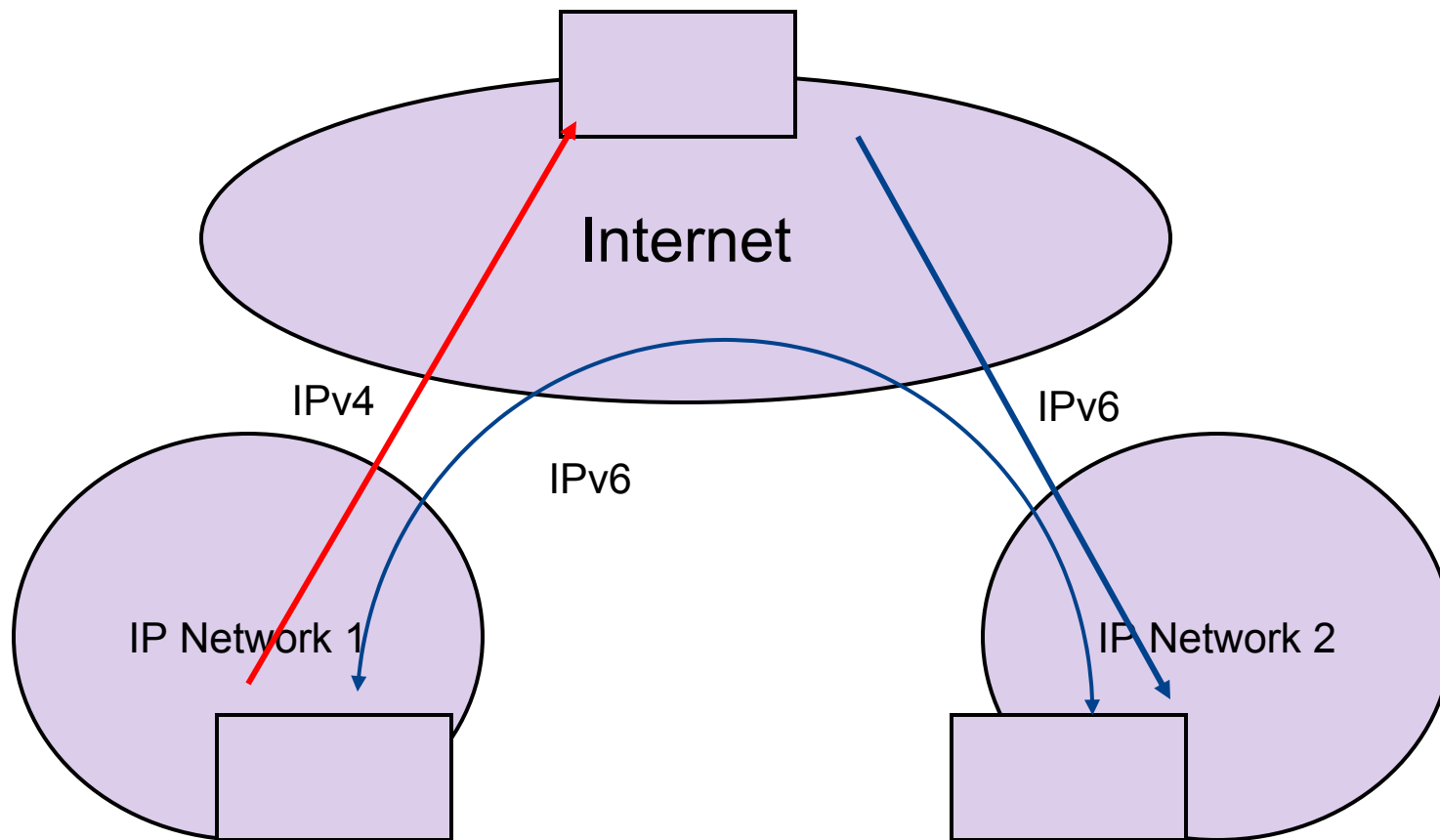

And research what kind of application requires End-End

Instant Message (SIP)

Instant Message (SIP) is End-End Service

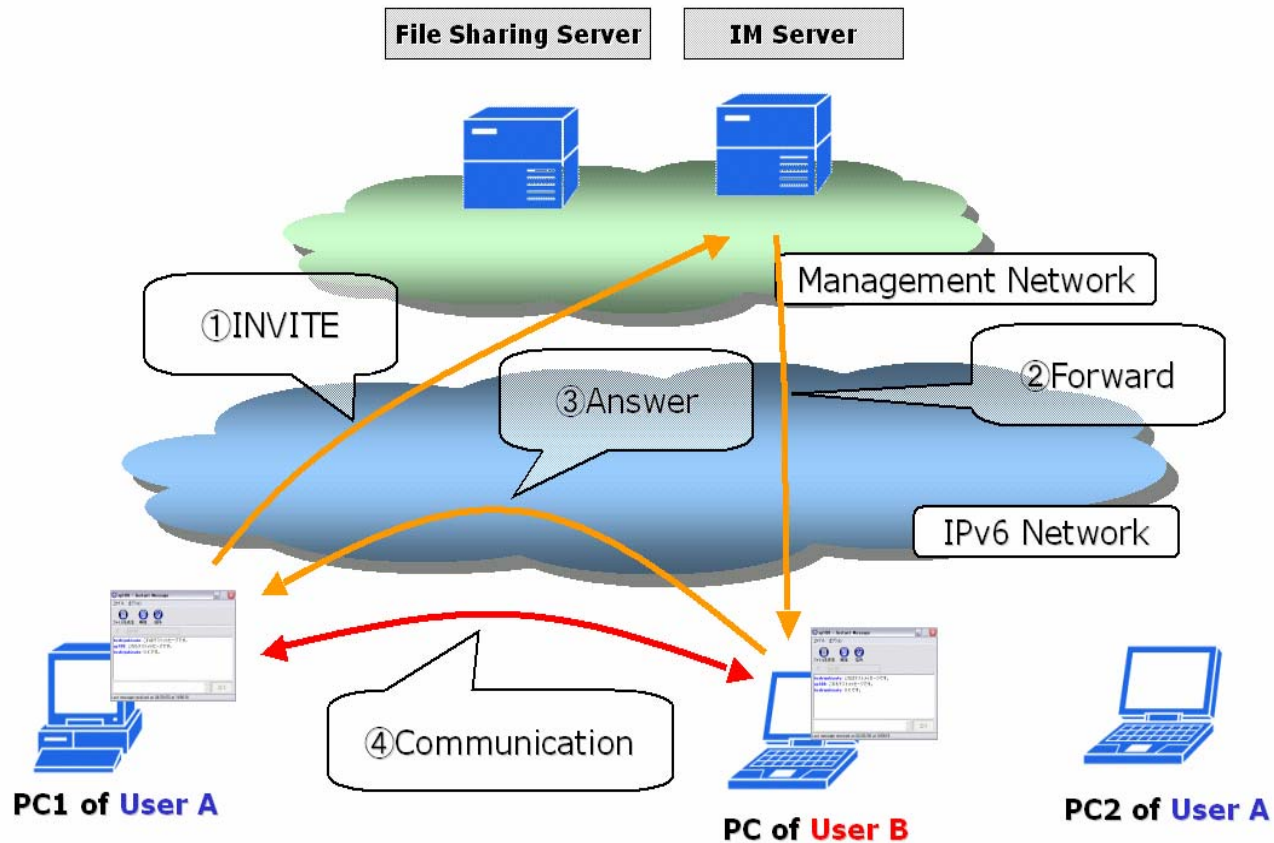

Without Global, IM sometimes needs traffic via Server

IM (Instant Message)

Service to provide

- Chat (Using **SIP/SIMPLE**)
- Meeting (Multi Chat)
- VoIP (Using SIP)
- File Transfer

Other Functions

- Access Control
- Mail Alerts

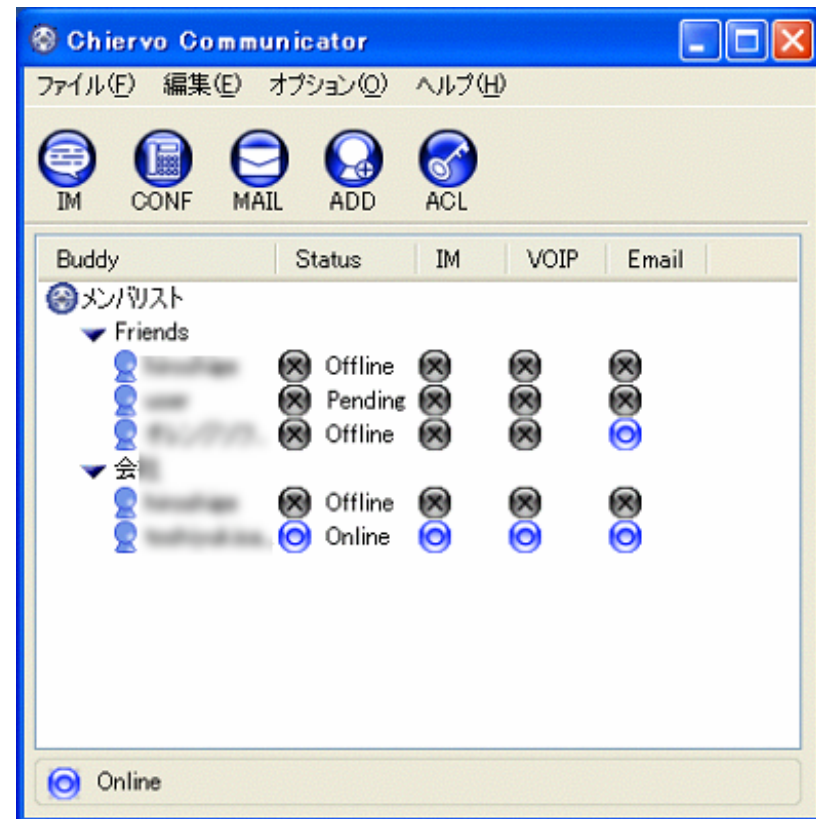

File Share

File Share is End-End Service

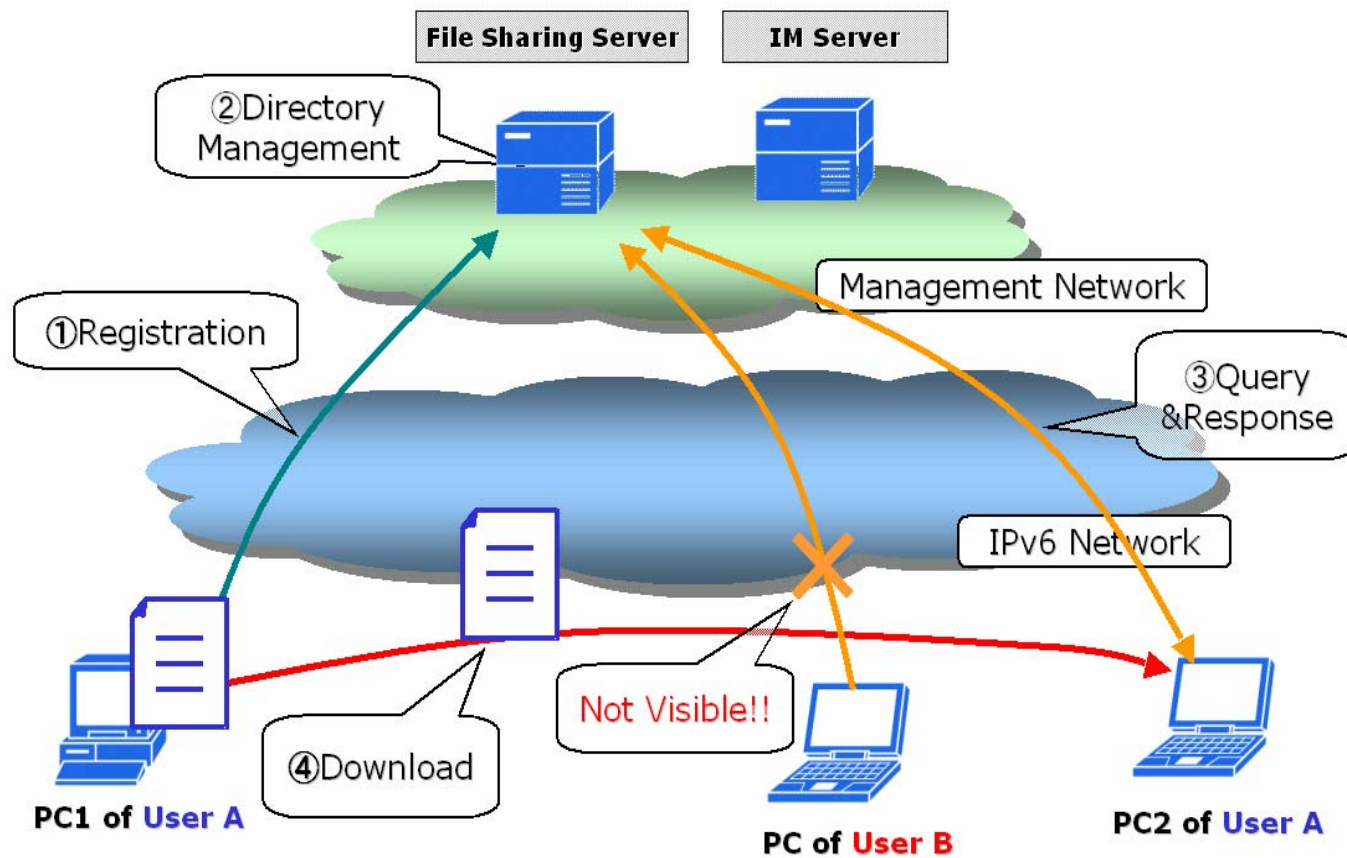

Without Global, Cannot upload, only download

P2P File Share

Service to provide

- Directory service for each person
- Easy access ranging from working place to the home

Plan to provide the file share services having no access restriction for all users participated, while a problem of copyright violation needs to be considered.

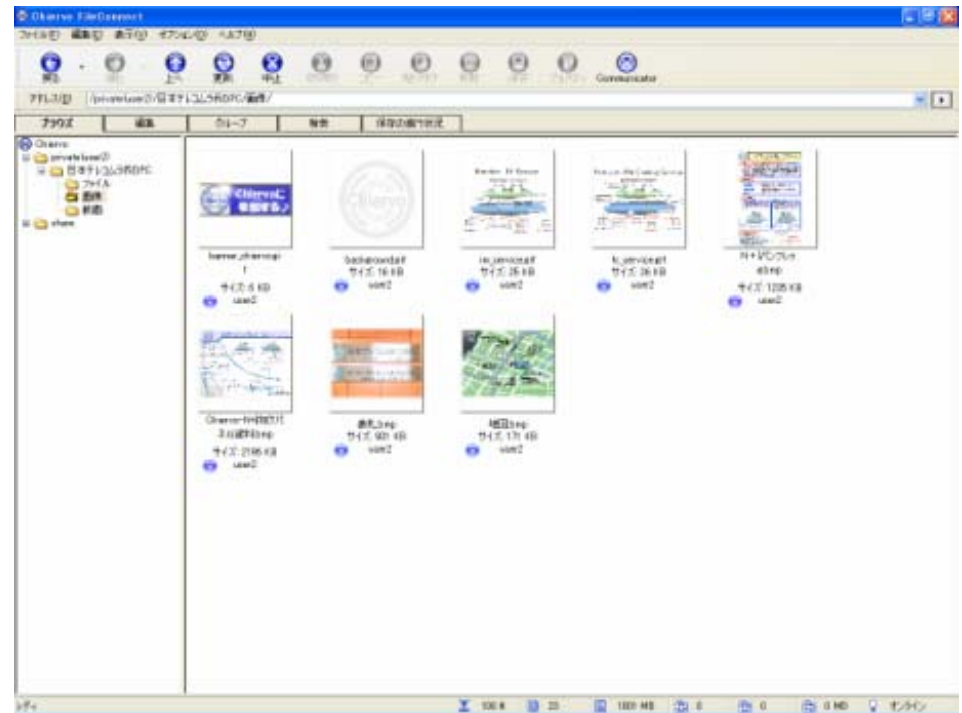

- ❑ Our Trial
- ❑ Service & Technology Details
- ❑ Activity & Future Plan

Media Coverage & PR Event

- From 2003/05/12 To 2003/10
 - Access www.chiervo.net Sorry, Japanese Only
- Wide Media Exposure and numerous Inquiries
 - Related news articles were printed in
 - Several dozen of major technology Web sites in Japan
 - Several media of Korea and China
 - v6start.net

- N+I, Feel6

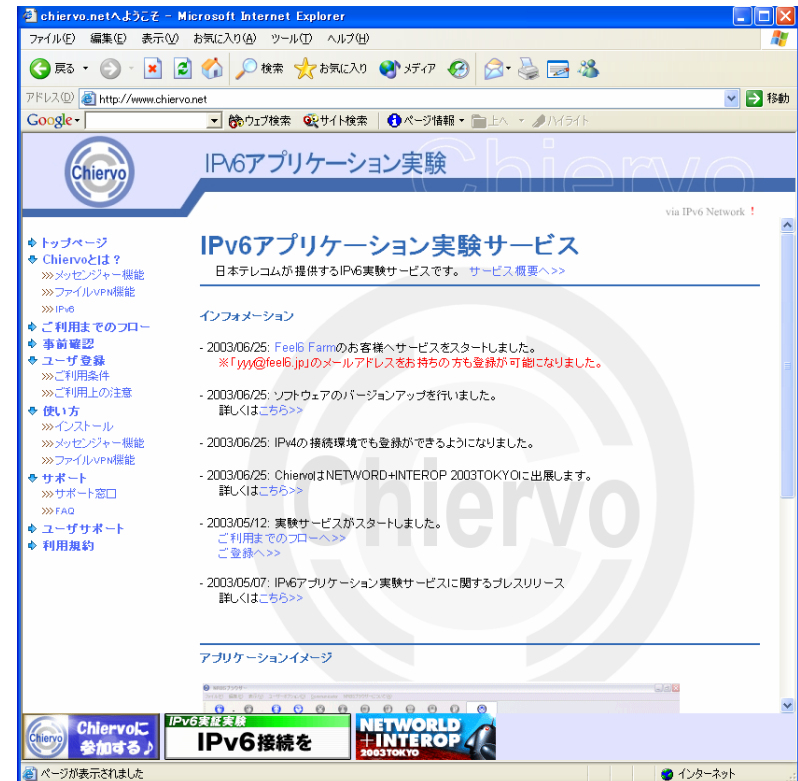

N+I IPv6 Show Case



Collaboration with Feel6

- Feel6 : IPv6 Tunneling Service with DTCP
<http://www.feel6.jp/>
- Next presentation.

Network with Feel6

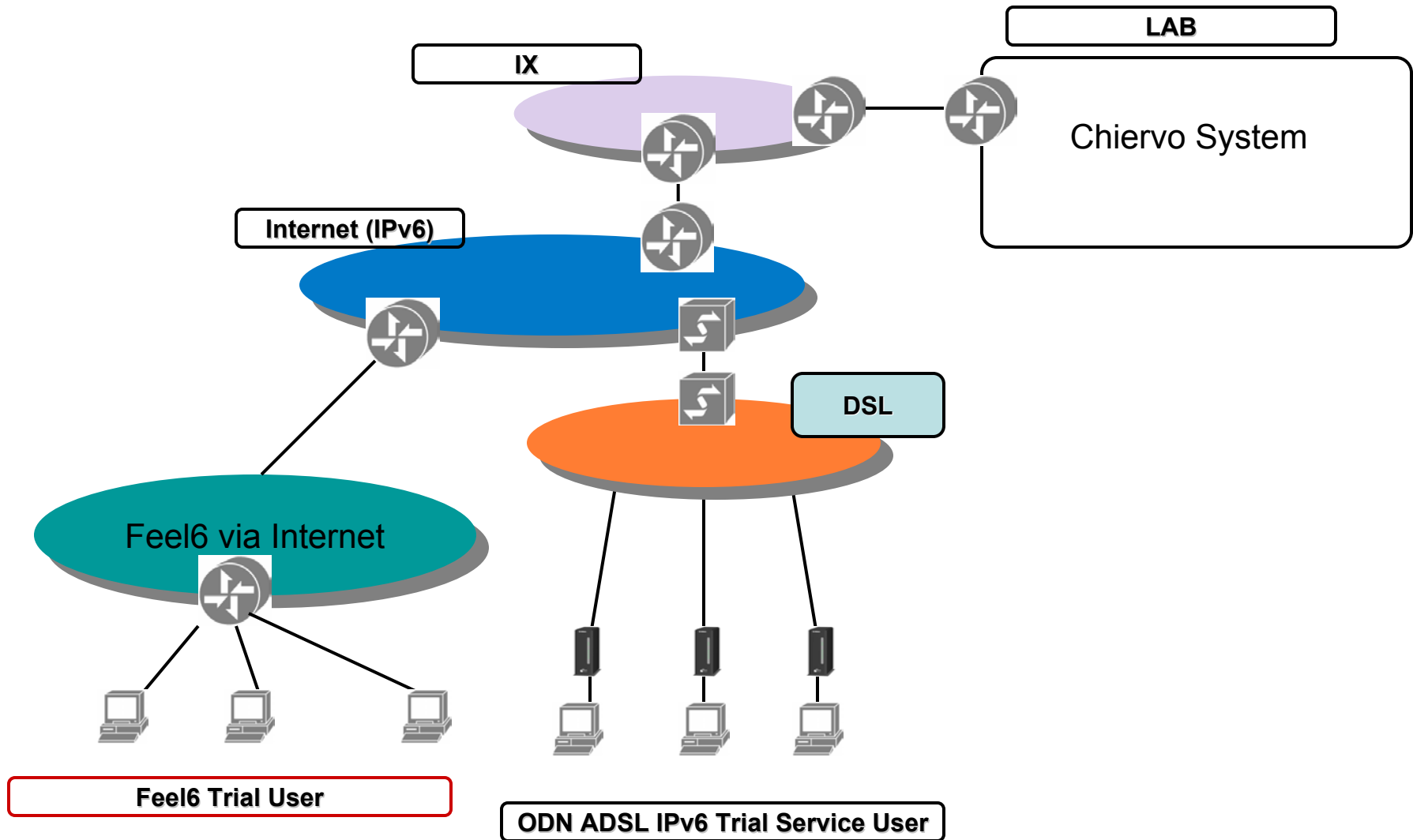

- Extention of the User Segment
 - Bring in not only those of Japan Telecom, but all IPv6 users
- Group File Share Application
- Launch of Community Site for Chiervo